

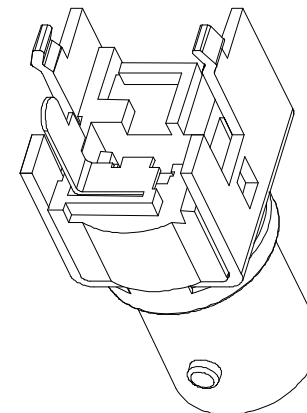

Product NO.	Renhotec-610-0038			
REV	DESCRIPTION	DWN	DATE	APPROVEN
A	First issue	Mr. Wang	2016/3/05	John kine

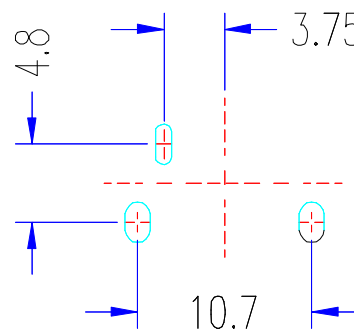
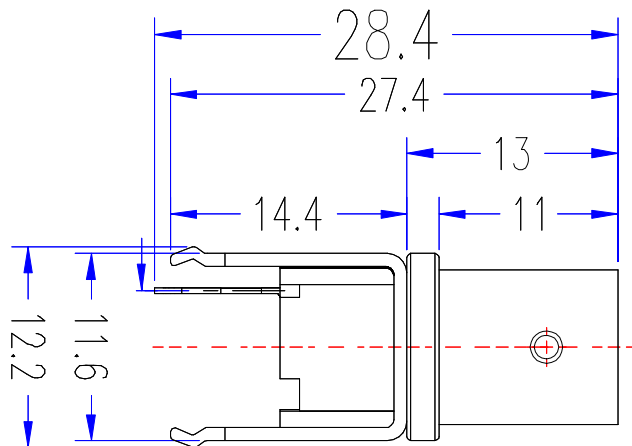
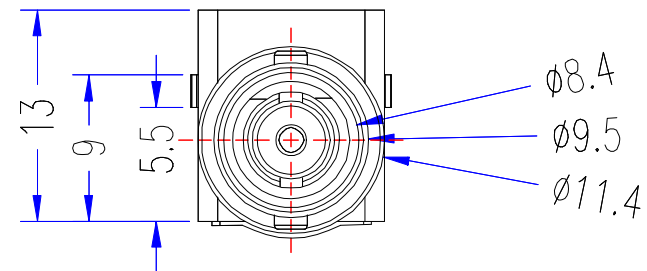
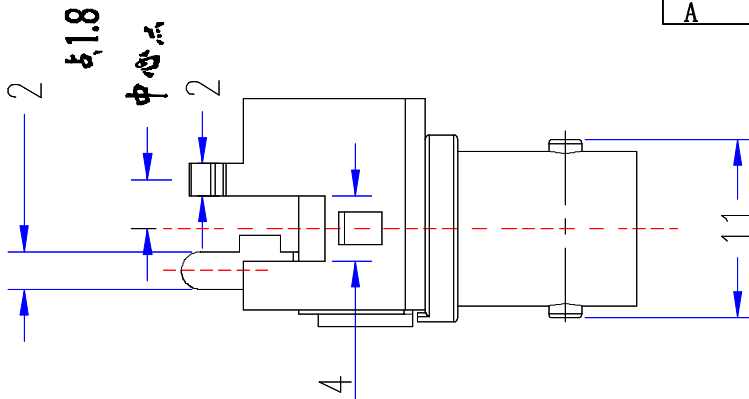
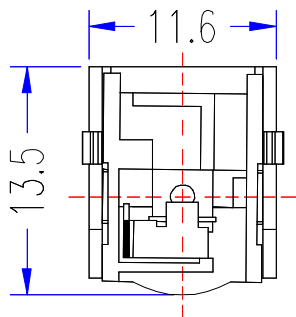

Specification:

Impedance:75. Ohms

VSWR:1.3MAX

Frequency range:DC~4G

Working Voltage:500V rms @ sea level

Insulation resistance:5000 Ohms min

Temperature range:-55°C TO +155°C

Relative temperature:≤95%(40° C±2° C)

Drawings products are in line with ROHS standards.

NOTE:

Tolerance

0-6 ±0.10
6-30 ±0.20
30-120 ±0.30
Angular ±2°

DRAWN 2016/03/05
Zelin. Zhang
CHECKED

View

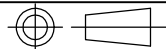

UNIT

MM

APPROVALS 09.03.2016
John Kine

SCALE

1:1



RENHOTEC GROUP

Name: BNC CONNECTOR DNN

SIZE A Product NO. RENHOTEC-610-0038

DateTime 2016/3/05

CAD FILE D/company drawings/BD

SHEET: 1 OF 1

3	BODY	ZINC	NICKEL	1
2	INSULATOR	POM	WHITE	1
1	PIN	BRASS	GOLD	1
NO	DESCRIPTION	MATERIAL	FINISH	QTY